



ESBE AB
Bruksgatan 22
SE-333 75 Reftele
www.esbe.eu



ESBE System Units
CIRCULATION UNIT DN25, DN32



Series GDA200
Series GFA200
Series GRA200

Series GRC200
Series GBA200

CE LVD 2014/35/EU
EMC 2014/30/EU
RoHS 2015/863/EU
ErP 2009/125/EU
RED 2014/53/EU

UK CA SI 2016 No. 1101
SI 2016 No. 1091
SI 2017 No. 3032
SI 2010 No. 2617
SI 2017 no. 1206

PED 2014/68/EU, article 4.3

SI 2016 No. 1105

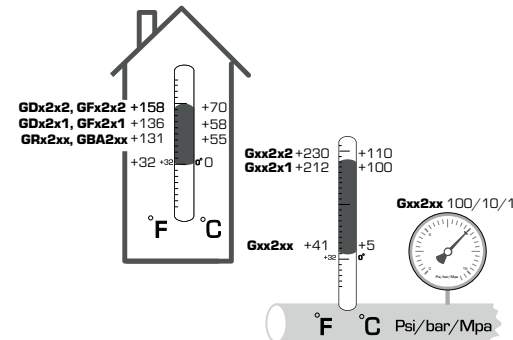

SERIES	FUNCTION
ESBE GDA211 GDA 212	
ESBE GFA211 GFA212	
GRA211 GRA212 GRA231 GRA232	
GRC221 GRC222 GRC241 GRC242	
ESBE GBA211	

Mtrl.nr: 98141083 • Ritn.nr: 7879 vers. C • Rev. 2023-06-12



Cabling • Dimensions

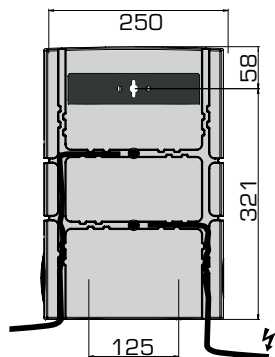

Mounting position

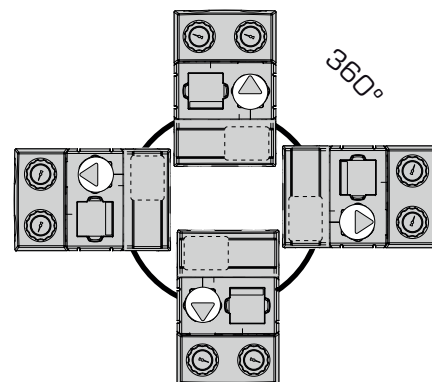
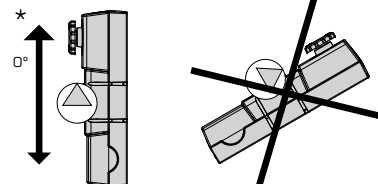

Remove actuator

Series GRA2xx, GBA211, GRC2xx

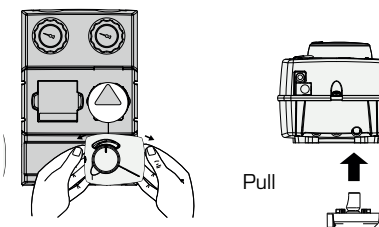

Disassembly insulation

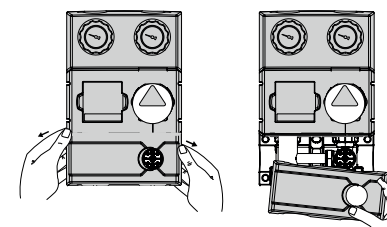

Fit supply pipes

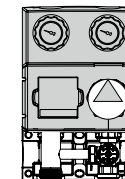

Assemble on manifold

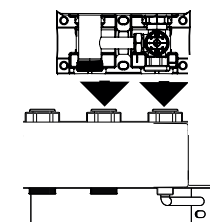

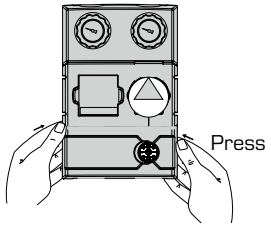
3**Assemble lower insulation****Assemble actuator**

Series GRA2xx, GBA211, GRC2xx

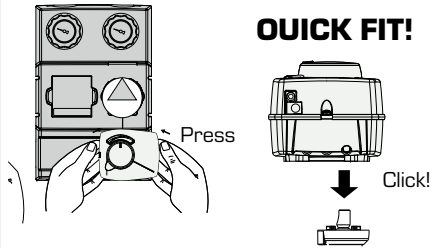
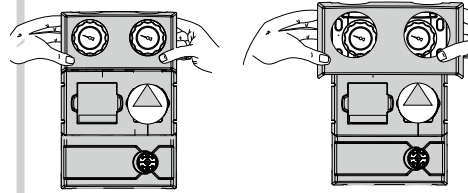
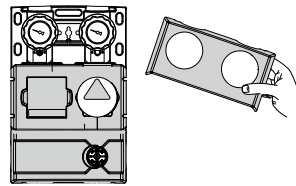
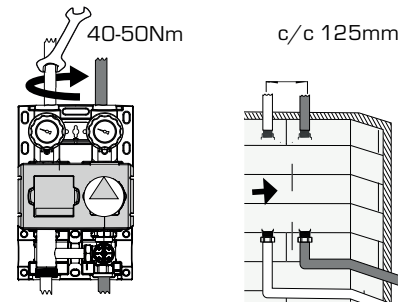
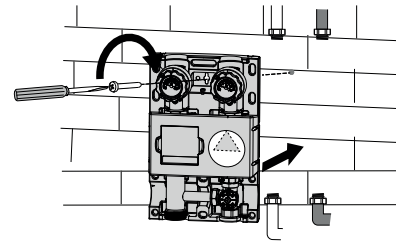
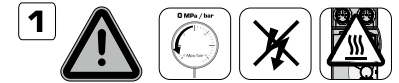
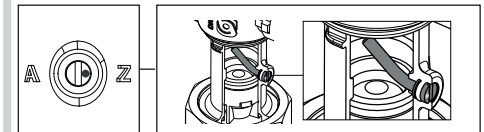
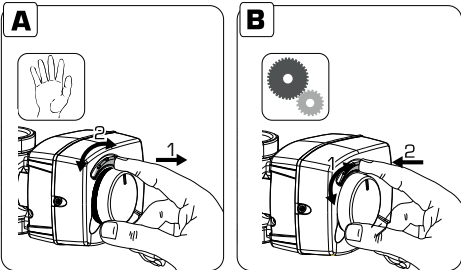
**4****Pull up insulation****Remove****5****Assembling on wall without manifold****i****Commissioning****1** **Filling and venting****i****Commissioning actuator:**

<https://esbe.eu/group/products/rotary-actuators>

i**Commissioning fixed temperature**

Series GFA211, GFA212

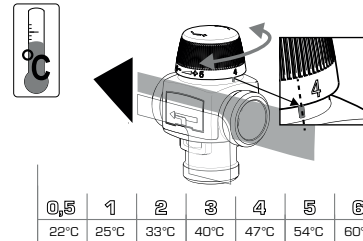

<https://esbe.eu/group/products/thermostatic-mixing-valves>

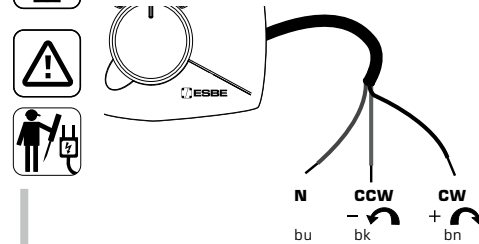
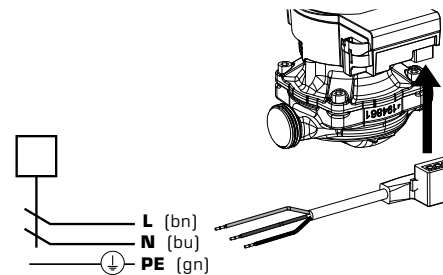
i**Electric installation****Power**

i www.esbe.eu

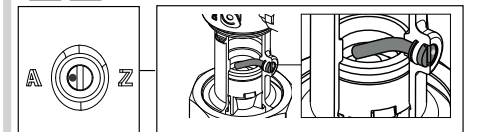
2 

Wilo Display

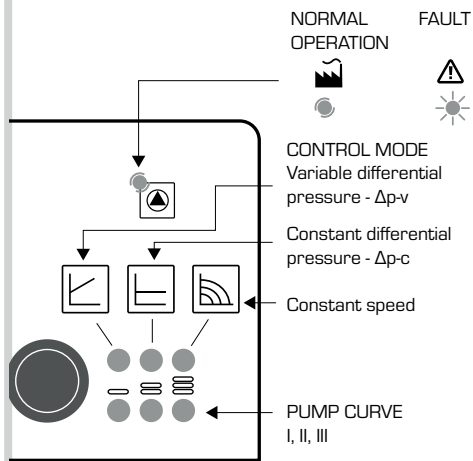

Pump Settings

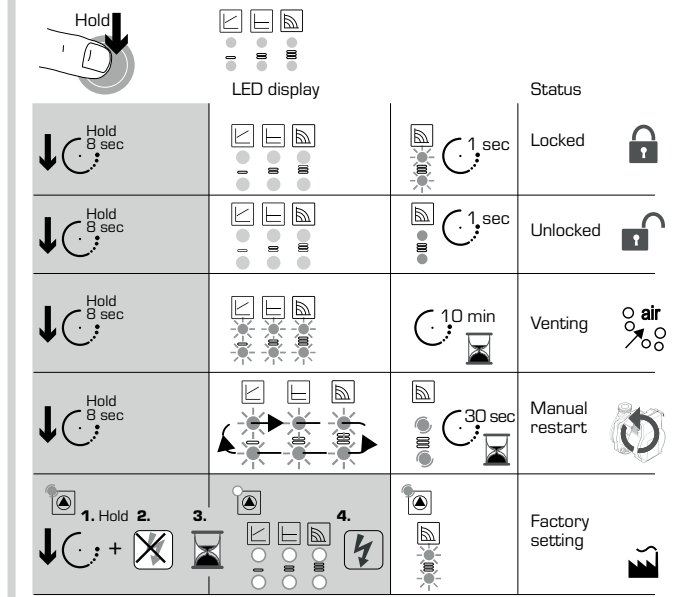

Settings navigations

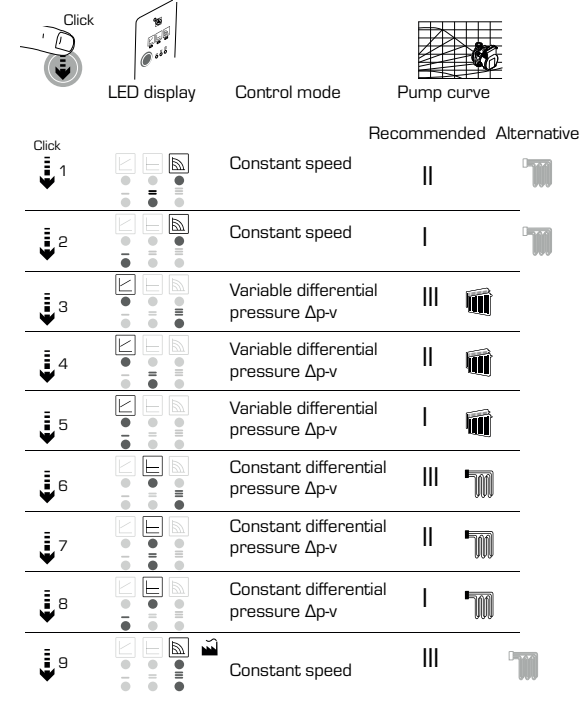

WILO - Faults, Causes and Remedies

LED Indicator	Meaning	Diagnostic	Cause	Remedy
lights green	Pump in operation	Pump runs according its setting	Normal operation	
blinks red/green	Pump in function but stopped	Pump restarts by itself after the fault is disappeared	1. Undervoltage $U < 160$ V or Overvoltage $U > 253$ V 2. Modul overheating: temperatur inside motor too high	1. Check voltage supply 195 V $< U < 253$ V 2. Check water and ambient temperature
blinks red	Pump out of function	Pump stopped (blocked)	Pump does not restart by itself due to a permanent failure	Change pump
blinks orange	Pump out of function	Pump stopped	Pump is not starting	Change pump
LED off	No power supply	No voltage on electronics	1. Pump is not connected to power supply 2. LED is damaged 3. Electronics are damaged	1. Check cable connection to power supply 2. Check if pump is running 3. Change pump

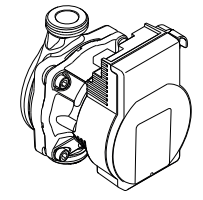

<http://www.esbe.eu/global/en/products/circulation units>

Factory setting

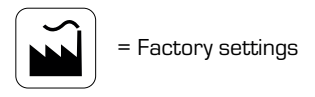



Grundfos Display

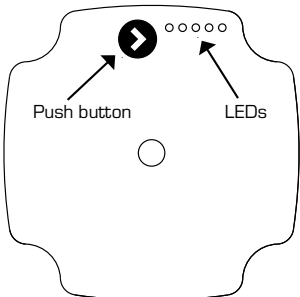

http://www.esbe.eu/global/en/products/circulation_units



Grundfos - Faults, Display and Solutions

FAULT	DISPLAY	SOLUTION
 OFF 0V	 4 dots	 1/On 0/Off
 ON 230V	 RED YELLOW	 1/On 0/Off 5 mm No.2
 ON <160V	 RED YELLOW	 L PE N
 ON 230V	 RED YELLOW	 1/On 0/Off

7

Settings navigation

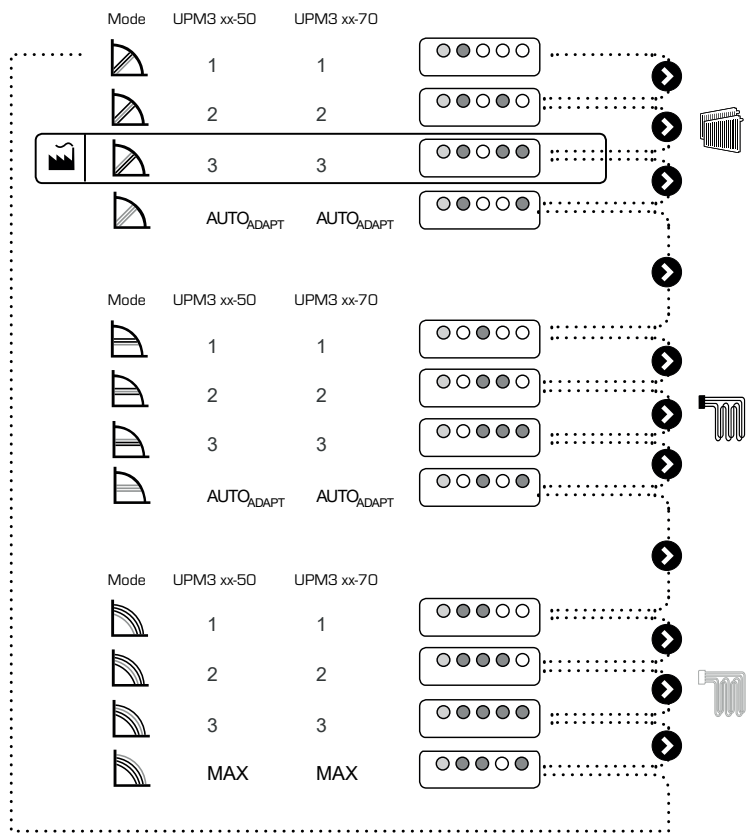
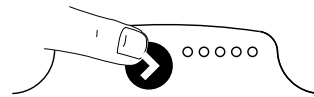

8

Expose application info using leaflet

