

MIXING VALVE SERIES VRB240

The compact rotary mixing valve series VRB240 for bivalent heating systems is available in DN 20, and is made of brass. Available with compression fittings. PN 10. Patented + Registered design.



Compression fitting

OPERATION

ESBE series VRB240 is a range of compact rotary mixing valve developed for bivalent systems, i.e. where two heat sources are connected in series or parallel. With an actuator and a control device, the ESBE VRB240 can be used to prioritize between heat sources. The VRB240 has the same port configuration and flow pattern as the old valve series BIV.

For easy manual operation the valves are equipped with non-slip knobs and end stops for an operation angle of 90°. The valve position scale can be turned over and rotated, allowing a wide choice of mounting positions. Together with actuator series ESBE ARA600, the VRB240 valves are also easily automated and have extraordinary regulating accuracy thanks to the unique valve-to-actuator interface. For more advanced control functions, the ESBE controllers allows even more applications.

ESBE VRB240 valves are available with compression fittings for pipe O.D. 22 mm.

FUNCTION

The bivalent valve has two inlets to which the heat sources can be connected either in parallel or in series. The primary, i.e. the low grade heat source should be connected to port 1 and the secondary to port 2. When no heat is needed, both ports 1 and 2 are closed. When heat is needed, the supply from port 1 is used as long as the required temperature can be maintained. When this is no longer the case the valve provides initially a mixed flow from ports 1 and 2. Finally port 2 is fully open and port 1 closed. (The function is like a 3-way valve but with two inlets instead of one.)

The bivalent valve may also be used on water storage tanks where two outlets from the tank are required. One outlet at the top of the tank and one half way down the tank serve the valve and the return line from the heating system is connected to the bottom of the tank. With this arrangement the hot water from the top of the tank will be used in conjunction with the cooler water drawn from the mid position.

SERVICE AND MAINTENANCE

The slender and compact design of the valve allows for easy tool access when assembling and disassembling the valve.

Repair kits are available for key components.

VALVE VRB240 DESIGNED FOR

- Heating
- Floor heating
- Comfort cooling
- Solar heating

SUITABLE ACTUATORS AND CONTROLLERS

- Series ARA600
- Series 90C
- Series 90*
- Series CRK210
- Series CRD220
- Series CRC210, CRC120*
- Series CRB210, CRB220
- Series CRA210, CRA120*

* Adaptor kit necessary

TECHNICAL DATA

Pressure class: _____ PN 10
 Media temperature: _____ max. (continuously) +110°C
 _____ max. (temporarily) +130°C
 _____ min. -10°C
 Torque (at nominal pressure): _____ < 5 Nm
 Leakrate in % of flow*: _____ < 0,5%
 Working pressure: _____ 1 MPa (10 bar)
 Max. differential pressure drop: _____ Mixing, 100 kPa (1 bar)
 _____ Diverting, 200 kPa (2 bar)
 Close off pressure: _____ 200 kPa
 Rangeability Kv/Kv^{min}, A-AB: _____ 100
 Connections: _____ Compression fitting, EN 1254-2

* Differential pressure 50kPa (0,5 bar)

Material

Valve body: _____ Dezincification resistant brass, DZR
 Slide: _____ Abrasion resistant brass
 Shaft and bushing: _____ PPS composite
 O-rings: _____ EPDM

CE PED 2014/68/EU, article 4.3



VALVE CHARACTERISTICS

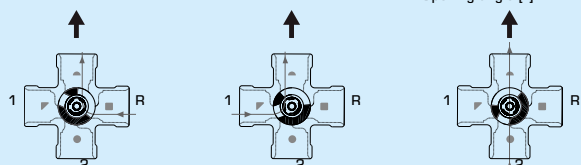
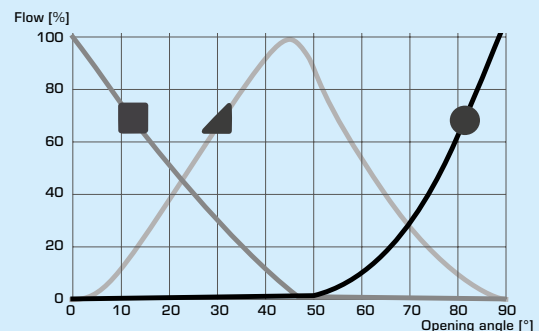

MIXING VALVE SERIES VRB240

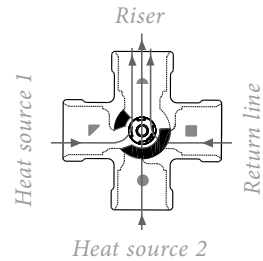
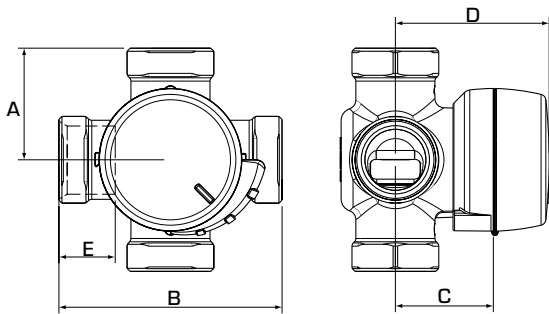

The flat-sided spindle top points towards the sleeve input.

SERIES VRB243, COMPRESSION FITTING

| Art. No. | Reference | DN | Kvs* | Connection | A | B | C | D | E | Weight [kg] | Note |
|----------|-----------|----|------|------------|----|----|----|----|---------|-------------|------|
| 11661800 | VRB243 | 20 | 4 | CPF 22 mm | 36 | 72 | 32 | 50 | 18 (x4) | 0,40 | |

* Kvs-value in m³/h at a pressure drop of 1 bar: CPF = compression fitting

INSTALLATION EXAMPLES

All the examples of installation can be mirrored. The valve position scale can be turned over and rotated to fit a number of installation layouts and shall at the installation be fitted in the correct position as shown in the instruction for installation. The symbol markings of the valve ports (■●▲) minimize the risk of incorrect installation.

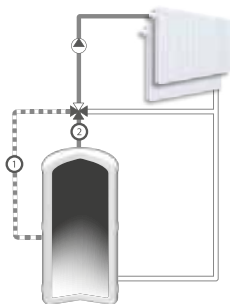

Storage tank mixing

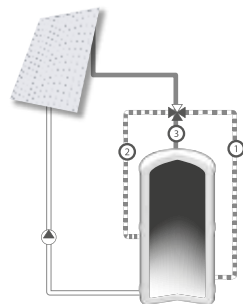

Storage tank loading

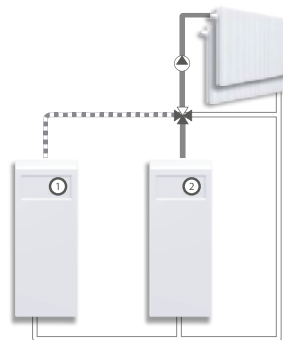

Parallel heat sources

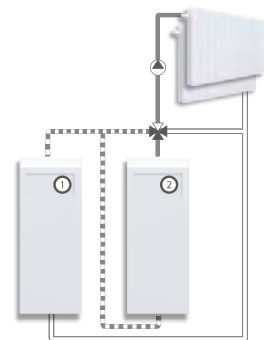

Serial heat sources

MIXING VALVE SERIES VRB240

DIMENSIONING

RADIATOR OR UNDERFLOOR HEATING SYSTEMS

Start with the heat demand in kW (e.g. 25 kW) and move vertically to the chosen Δt (e.g. 15°C).

Move horizontally to the shaded field (pressure drop of 3-15 kPa) and select the smaller Kvs-value (e.g. 4.0).

OTHER APPLICATIONS

Make sure maximum ΔP is not exceeded (see lines A and B in the graph below).

