

LOAD UNIT SERIES LTC300

The ESBE load unit series LTC300 is used to automatically and efficiently load storage tanks and protect solid fuel boilers from too low return temperatures, which otherwise could cause tarring, reduced output and shorter life span of the boiler. The load unit is developed according to the European Directive 2009/125/EC regarding Eco-design of Energy Related Products.

OPERATION

The ESBE series LTC300 is a load unit designed to protect the boiler from return temperatures that are too low. Maintaining a high and stable return temperature enables a higher level of boiler efficiency, reduced tarring and increased life span of the boiler.

The LTC300 is used in heating applications where solid fuel boilers are used to feed storage tanks.

FUNCTION

The load unit consists of an integrated pump and a thermic valve, designed to make both assembly and operation easy.

The pump speed is adjustable, enabling the pump speed to be set correctly for the system and optimizing the loading of the storage tank.

The load unit is protected by an insulation shell and is fitted with easily readable thermometers.

The valve regulates on two ports, which makes it easy to install and does not require any balancing valve in the by-pass pipe.

The LTC300 has an integrated auto-circulation function which makes the unit operational even during power failure or pump failure. The circulation function is blocked at delivery, but can easily be activated if required.

An integrated venting function is included in the LTC300. By alternating for 10 minutes, between low and high speed of the pump, any residual air is pushed out of the load unit and can be vented from the system. After the routine is run, the pump automatically switches to the pre-set speed.

The valve contains a thermostat which begins to open connection A when the outgoing mixed water temperature in connection AB exceeds the lower end of the regulating range. Connection B is fully closed when the temperature in connection A exceeds the nominal temperature with 5°C.

MOUNTING

The pump is equipped with a power supply cable of 3,0 meters.

MEDIA

Maximum 50% glycol for freezing protection and oxygen absorbing compounds are allowed as additives. As both the viscosity and the thermal conduction are affected when glycol is added to the system water, this fact has to be considered when dimensioning the unit.



Internal thread



LOAD UNIT LTC300 DESIGNED FOR

- Heating

TECHNICAL DATA

Pressure class: _____ PN 6
 Temperature of medium: _____ max. 110°C
 _____ min. 0°C
 Ambient temperature: _____ max. 60°C
 _____ min. 0°C
 Leakrate A - AB: _____ max. 0,5% of max. flow (Q_{max})
 Leakrate B - AB: _____ max. 3% of max. flow (Q_{max})
 Rangeability K_v/K_v^{min} : _____ 100
 Supply voltage: _____ 230 ± 10% VAC, 50 Hz
 Max. power consumption - LTC341: _____ 20 W
 - LTC361: _____ 43 W
 - LTC381: _____ 80 W
 Energy classification: _____ A
 EEI (Energy Efficiency Index), circulation pump: _____ ≤0,20
 Power supply cable: _____ 3,0 m
 Connections: _____ Internal thread (G), ISO 228/1

Material

Valve body: _____ Nodular iron EN-JS 1050



LVD 2014/35/EU
 EMC 2014/30/EU
 RoHS3 2015/863/EU
 ErP 2009/125/EU



SI 2016 No. 1101
 SI 2016 No. 1091
 SI 2012 No. 3032
 SI 2010 No. 2617

PED 2014/68/EU, article 4.3 / SI 2016 No. 1105 (UK)

FLOW PATTERN

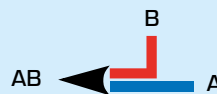

LOAD UNIT SERIES LTC300

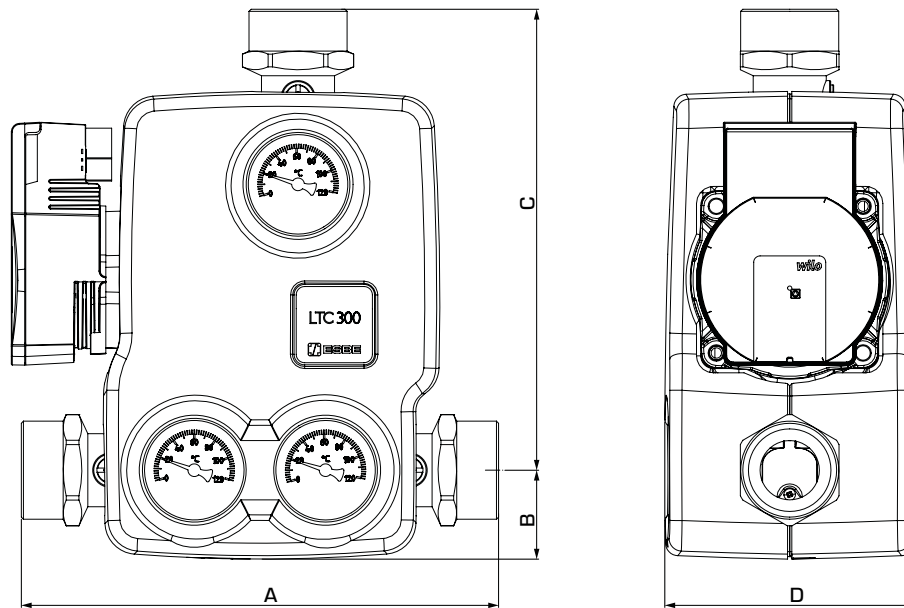

SERIES LTC341 Internal thread with electronic 4 m pump

Art. No.	Reference	DN	Connection Adapter	Power* [kW] (max. Δt)		Opening temperature	A	B	C	D	Weight [kg]
55005300	LTC341	25	G 1"	60	35	55°C ± 5°C	213	42	212	118	4,4
55005400				50	30	60°C ± 5°C					
55005500				45	25	65°C ± 5°C					

SERIES LTC361 Internal thread with electronic 6 m pump

Art. No.	Reference	DN	Connection Adapter	Power* [kW] (max. Δt)		Opening temperature	A	B	C	D	Weight [kg]
55006000	LTC361	25	G 1"	90	35	55°C ± 5°C	213	42	212	118	4,4
55006100				80	30	60°C ± 5°C					
55006200				65	25	65°C ± 5°C					
55006300				50	20	70°C ± 5°C					
55006400	LTC361	32	G 1¼"	90	35	55°C ± 5°C	227	42	219	118	4,6
55006500				80	30	60°C ± 5°C					
55006600				65	25	65°C ± 5°C					
55006700				50	20	70°C ± 5°C					

SERIES LTC381 Internal thread with electronic 8 m pump

Art. No.	Reference	DN	Connection Adapter	Power* [kW] (max. Δt)		Opening temperature	A	B	C	D	Weight [kg]
55006800	LTC381	40	G 1 ½"	110	35	55°C ± 5°C	225	42	218	118	4,6
55006900				95	30	60°C ± 5°C					
55005200				80	25	65°C ± 5°C					

* The following recommendations apply only for this product.
For the overall system requirements, restrictions in the possible power output can occur, (available Δp = 15 kPa).

LOAD UNIT SERIES LTC300

DIMENSIONING

Example: Start with the heat output of the boiler (e.g. 40 kW) and move horizontally to the right in the diagram to the chosen Δt (recommended by boiler supplier), which is the temperature difference between the riser from the boiler and the return to the boiler (e.g. $85^{\circ}\text{C} - 65^{\circ}\text{C} = 20^{\circ}\text{C}$).

Move vertically up to the curves representing load unit performance. Check that the pump curve overcomes the additional pressure drops in system components such as pipes, boiler and storage tank.

LTC341 – available pressure of the pump, constant speed

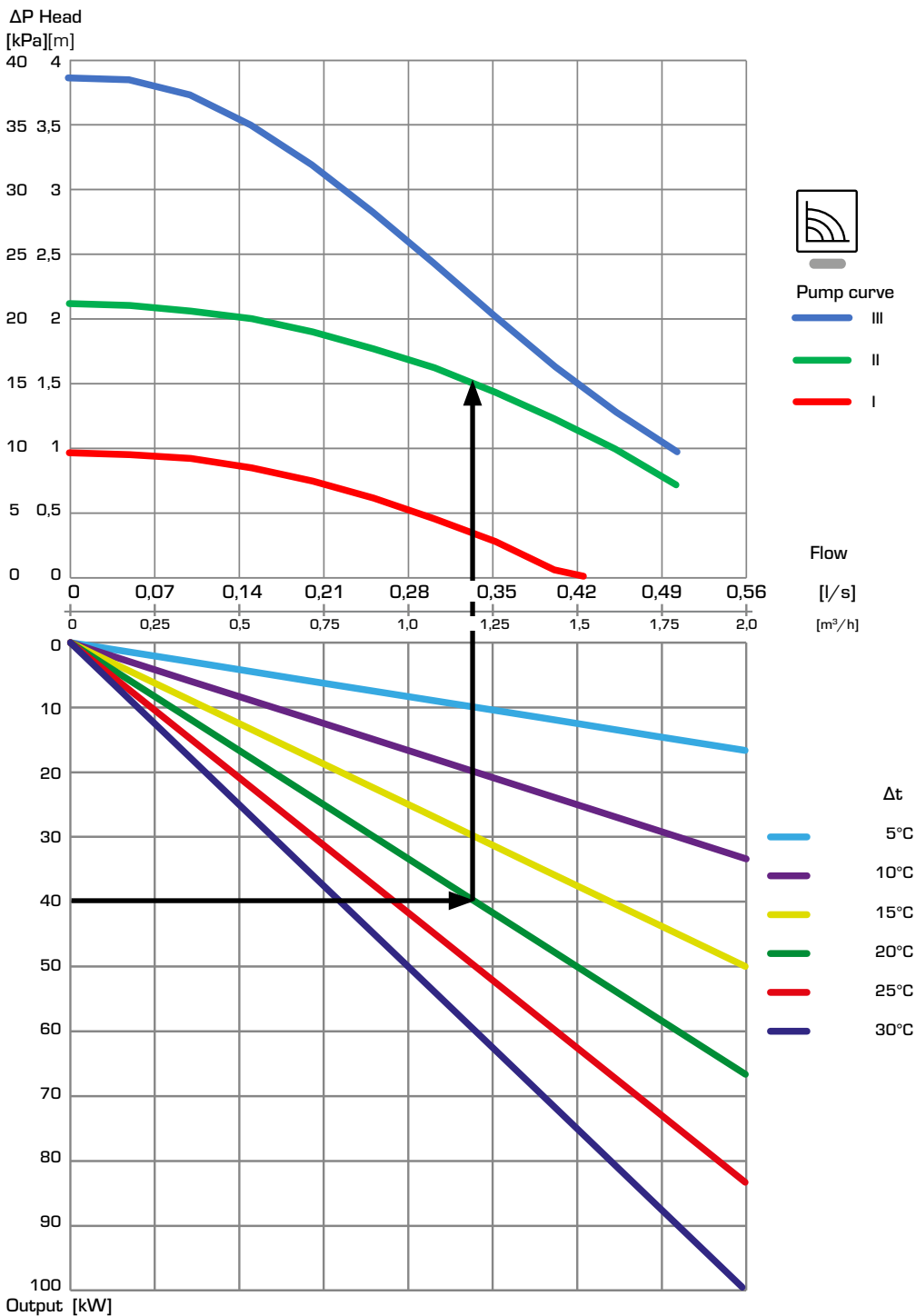

LOAD UNIT SERIES LTC300

DIMENSIONING

Example: Start with the heat output of the boiler (e.g. 40 kW) and move horizontally to the right in the diagram to the chosen Δt (recommended by boiler supplier), which is the temperature difference between the riser from the boiler and the return to the boiler (e.g. $85^{\circ}\text{C} - 65^{\circ}\text{C} = 20^{\circ}\text{C}$).

Move vertically up to the curves representing load unit performance. Check that the pump curve overcomes the additional pressure drops in system components such as pipes, boiler and storage tank.

LTC361 – available pressure of the pump, constant speed

ΔP Head
[kPa][m]

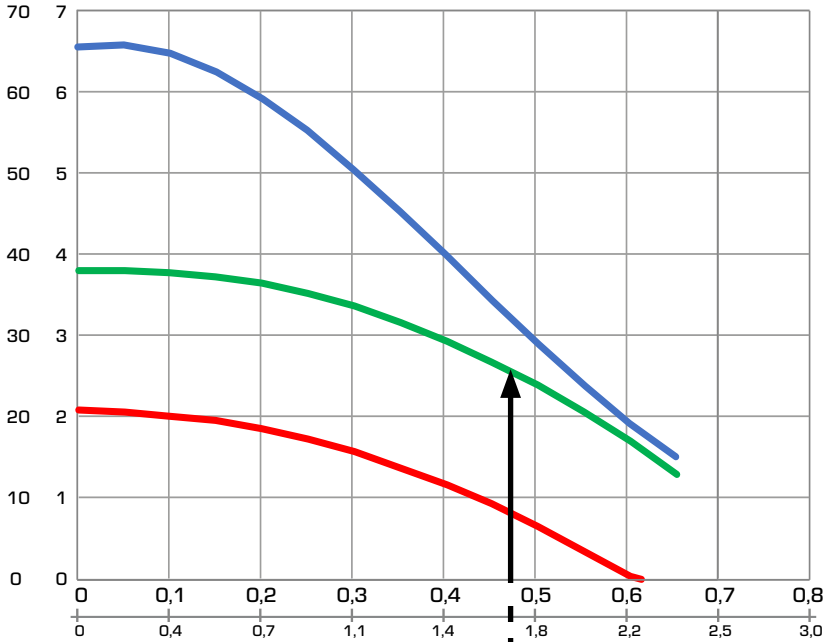

Pump curve
III
II
I

Flow
[l/s]
[m³/h]

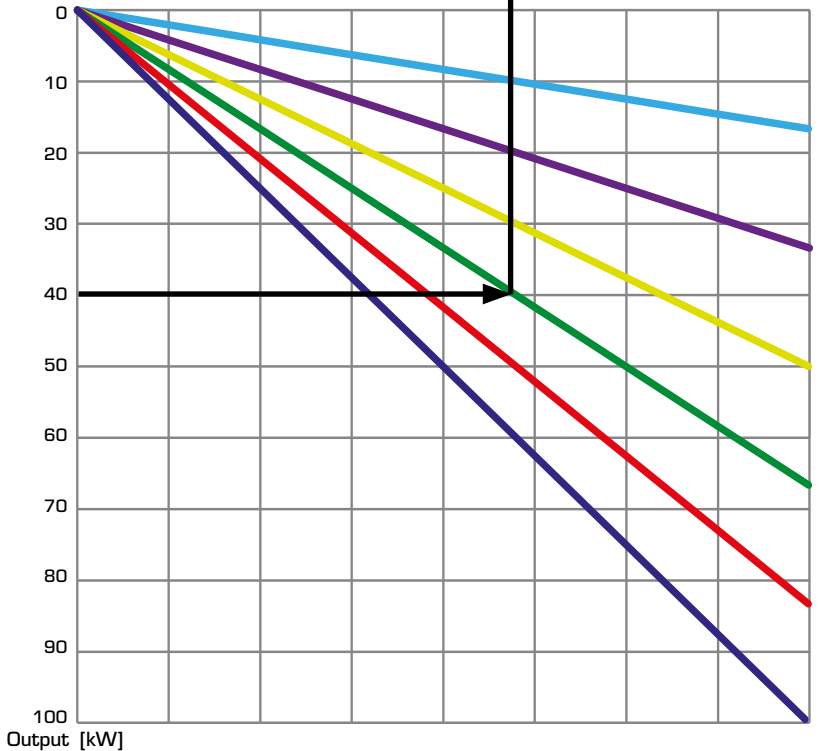

Δt
5 $^{\circ}\text{C}$
10 $^{\circ}\text{C}$
15 $^{\circ}\text{C}$
20 $^{\circ}\text{C}$
25 $^{\circ}\text{C}$
30 $^{\circ}\text{C}$

LOAD UNIT SERIES LTC300

DIMENSIONING

Example: Start with the heat output of the boiler (e.g. 40 kW) and move horizontally to the right in the diagram to the chosen Δt (recommended by boiler supplier), which is the temperature difference between the riser from the boiler and the return to the boiler (e.g. $85^{\circ}\text{C} - 65^{\circ}\text{C} = 20^{\circ}\text{C}$).

Move vertically up to the curves representing load unit performance. Check that the pump curve overcomes the additional pressure drops in system components such as pipes, boiler and storage tank.

LTC381 – available pressure of the pump, constant speed

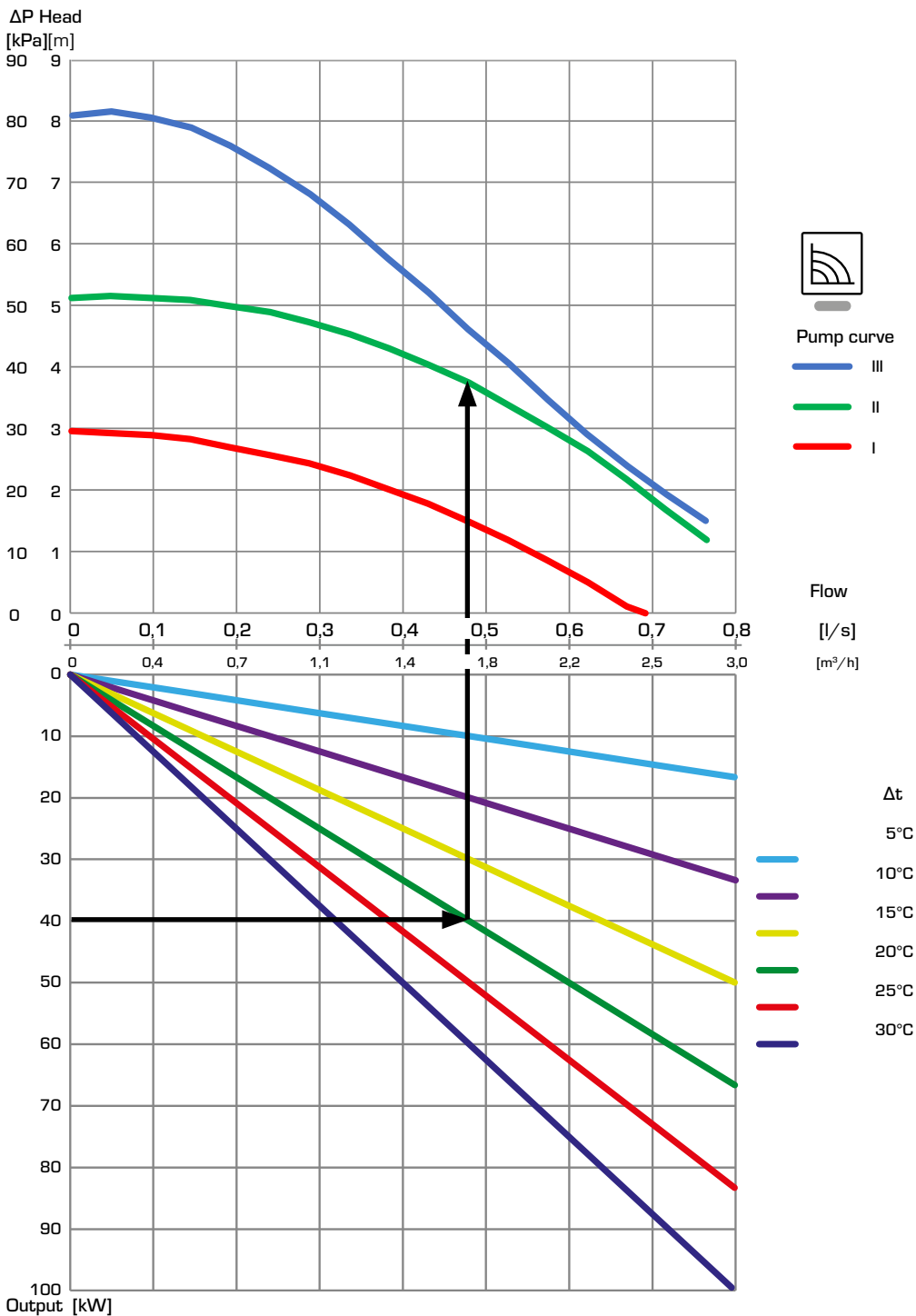

LOAD UNIT SERIES LTC300

INSTALLATION EXAMPLE

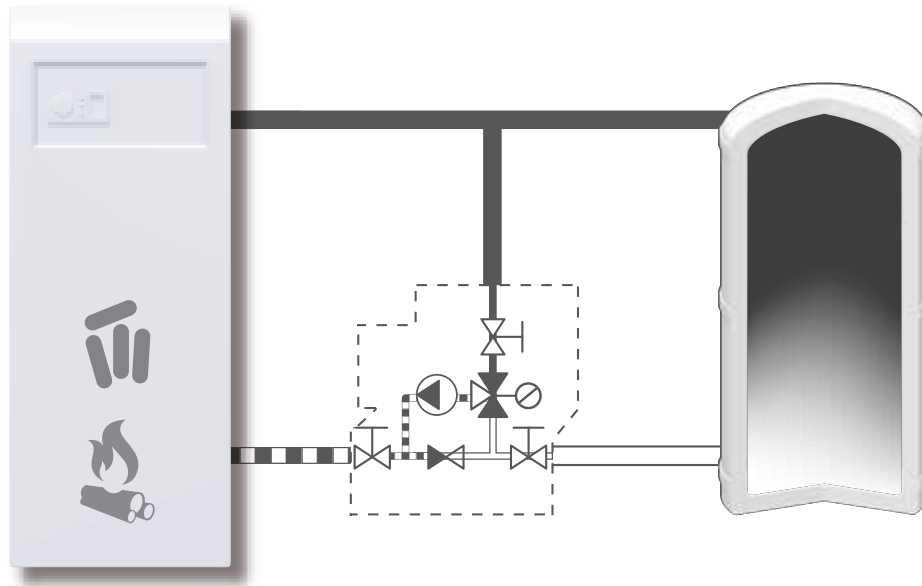

SERVICE AND MAINTENANCE

The load unit is equipped with shut off ball valves to facilitate future service.

The load unit does not need any maintenance under normal conditions. However thermostats are available and are easy to replace if necessary.

OPTIONS

- Thermostat 55°C _____ Art. No. 57020200
- Thermostat 60°C _____ Art. No. 57020300
- Thermostat 65°C _____ Art. No. 57020800
- Thermostat 70°C _____ Art. No. 57020400