

ROTARY MOTORIZED VALVES
MIXING VALVE
SERIES 4F

4F, DN 40-100, cast iron, PN 6. Flange.



Flange

OPERATION

The ESBE series F is a valve made of cast iron for use in heating and cooling installations.

The mixing proportions are adjusted manually with a handle or, in automatically controlled systems, by means of an actuator. Suitable actuators are ESBE series ARC300 or series 90. The valve can also be equipped with ESBE controllers series CRA120 and CRC120.

Valve series 4F is available in dimensions DN 40-100 with flanged connections.

The scale is graded on both sides and can be turned, allowing a choice of mounting positions. Operation angle = 90°.

SERVICE AND MAINTENANCE

All major parts are replaceable. The shaft seal consist two o-rings, one of which can be replaced without the need for draining down the system or dismantling the valve. However, before doing so, the system must be depressurized.

INSTALLATION EXAMPLES

All the examples of installations can be reversed. The valve position plate is graded on both sides and should at the installation be fitted in the correct position as shown in the instruction for installation.

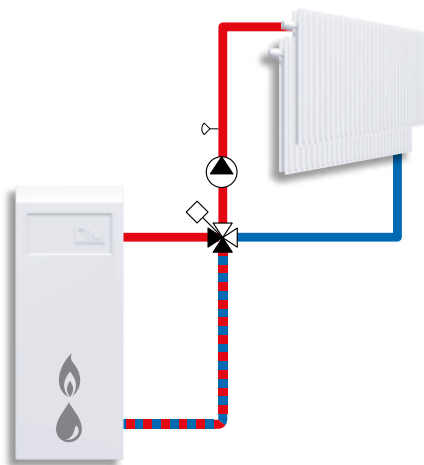

VALVE 4F DESIGNED FOR

- Heating
- Comfort cooling

SUITABLE ACTUATORS AND CONTROLLERS

- Series 90
- Series CRA120
- Series ARC300
- Series CRC120

TECHNICAL DATA

Pressure class: _____ PN 6
 Media temperature: _____ max. 110°C
 _____ min. - 10°C
 Differential pressure drop: _____ max. 50 kPa
 Leakrate in % of flow: _____ Mixing, max. 1,5% of Kvs
 _____ Diverting, max. 1,0% of Kvs
 Rangeability Kv/Kv^{min}: _____ 100
 Connection: _____ Flange according to EN 1092-2
 Media: _____ Heating water (in accordance with VDI2035)
 _____ Water / Glycol mixtures, max. 50%
 _____ Water / Ethanol mixtures, max. 28%

Material
 Valve body: _____ Cast iron EN-JL 1030
 Slide: _____ brass CW 614N and stainless steel
 Bushing: _____ brass CW 602N
 Cover plate: _____ cast iron
 O-rings: _____ EPDM

PED 2014/68/EU, article 4.3 / SI 2016 No. 1105 (UK)

MIXING VALVE SERIES 4F

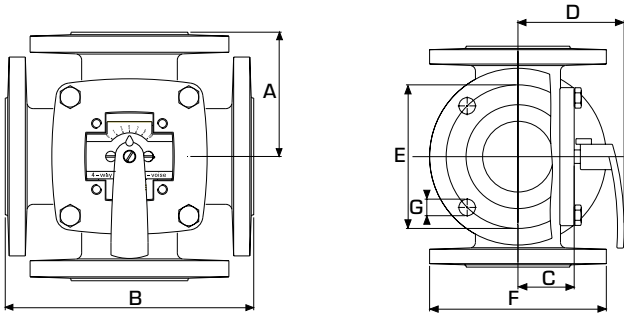

Flanged connection PN6,
standard EN 1092-2

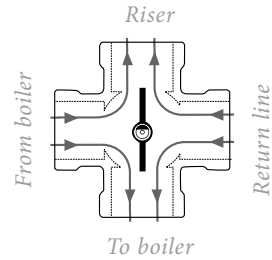

The flat-sided spindle top
(as well as the indicator of the knob)
points towards the sleeve position.

SERIES 4F



Art. No.	Reference	DN	Kvs*	A	B	C	D	E	F	G	Weight [kg]
11101800	4F 40	40	44	88	175	40	82	100	130	4x15	8,2
11101900	4F 50	50	60	98	195	50	92	110	140	4x15	11,0
11102000	4F 65	65	90	100	200	50	92	130	160	4x15	12,2
11102100	4F 80	80	150	120	240	65	108	150	190	4x18	20,0
11102200	4F 100	100	225	132	265	81	124	170	210	4x18	25,0

* Kvs-value in m³/h at a pressure drop of 1 bar. Flow chart, see product catalogue.

SELECTION GUIDE ESBE ACTUATORS

The figures below are intended only as a recommendation for ordinary installations. In some applications the valve may require even more actuator torque.

MAXIMUM DIFFERENTIAL PRESSURE			
Actuator			
	ARA600	90	ARC300
Torque	6 Nm	15 Nm	30 Nm
DN	max. ΔP [kPa]		
20	50	50	50
25			
32			
40			
50			
65	—	30	—
80	—		
100	—	30	—

MAXIMUM FLOW			
Actuator			
	ARA600	90	ARC300
Torque	6 Nm	15 Nm	30 Nm
DN	max. flow [m ³ /h]		
20	8,5	8,5	8,5
25	13	13	13
32	20	20	20
40	31	31	31
50	42	42	42
65	—	64	64
80	—	110	110
100	—	120	160

ROTARY MOTORIZED VALVES
MIXING VALVE
SERIES 4F

VALVE CHARACTERISTICS

Flow [%]

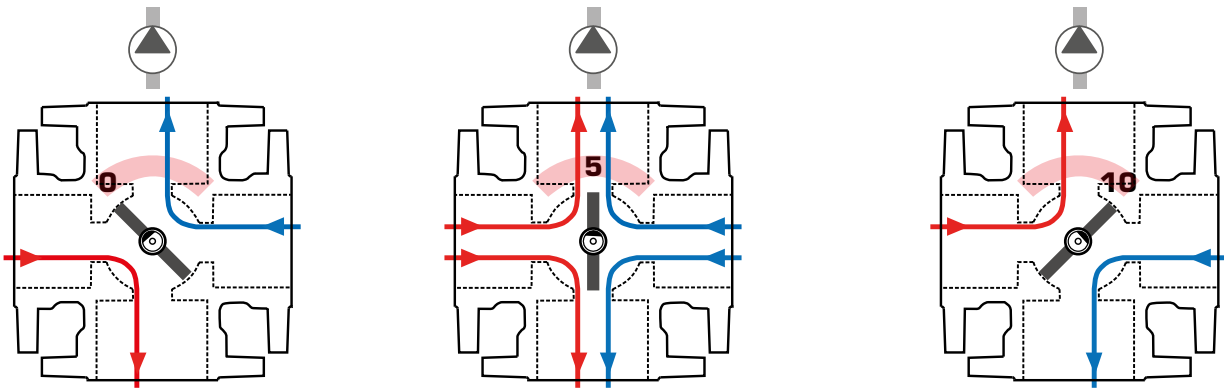
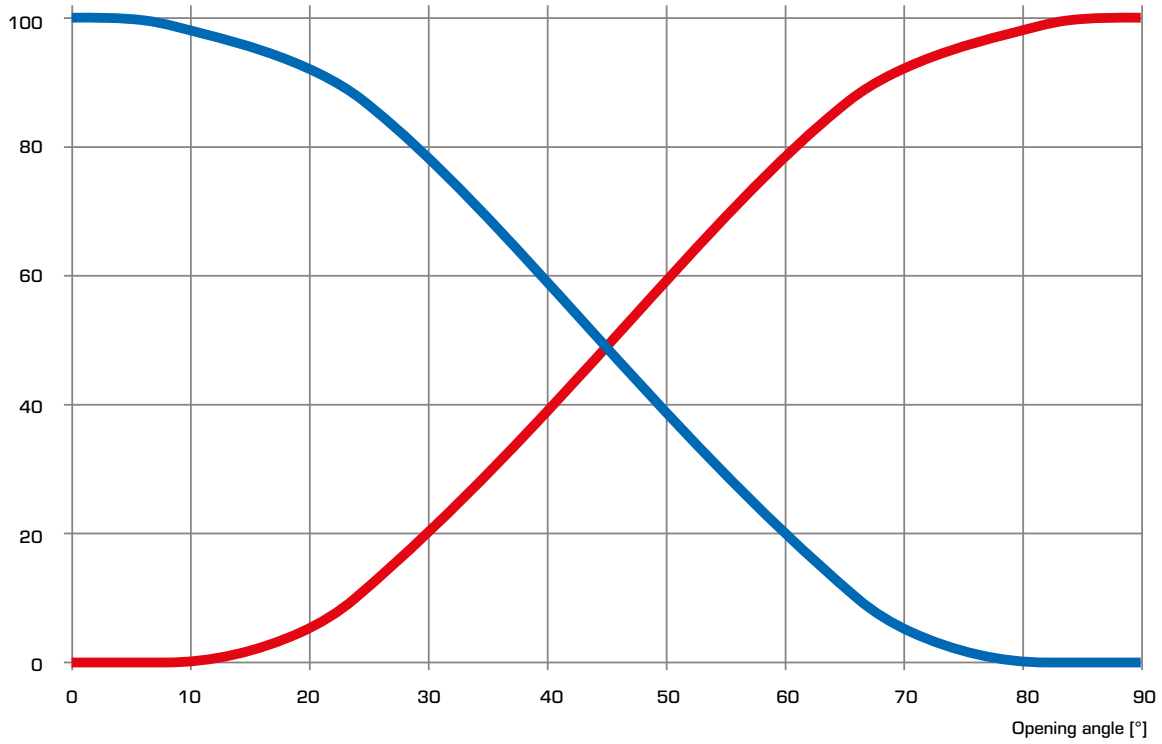

MIXING VALVE SERIES 4F

DIMENSIONING

HEATING SYSTEMS (RADIATOR OR UNDERFLOOR HEATING SYSTEMS)

Start with the heat demand in kW (e.g. 200 kW) and move vertically to the chosen Δt (e.g. 10°C).

Move horizontally to the shaded field (pressure drop of 3-15 kPa) and select the smaller Kvs-value (e.g. 60). A mixing valve with suitable Kvs-value will be found in respective product description.

OTHER APPLICATIONS

Make sure maximum ΔP is not exceeded (see lines A to E in the graphs below).

